



REVERSE

ÉCONOMIE & SIMPLICITÉ

**INSTALLATION DANS
COULISSES EXISTANTES DE 18MM MINIMUM**

LARGEUR MAXIMUM 2400MM

**ORIENTATION DES LAMES 60° FIXE
ENROULEMENT EXTÉRIEUR**

ROLLTEK OLA REVERSE

Volet roulant lames orientables et enroulement extérieur

Rolling Shutter with adjustable slats and external winding

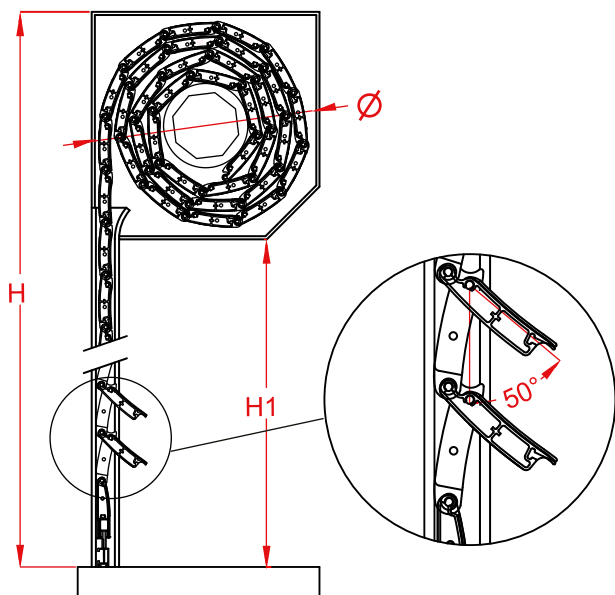

Largeur maximum 2,4 m
Maximum width 2,4 m

DIAMÈTRE D'ENROULEMENT WINDINGS

H1	Ø
1000	175
1200	185
1400	195
1600	202
1800	215
2000	220
2200	225
2400	235
2600	250
2800	255
3000	260

Misure in mm
Values are in mm

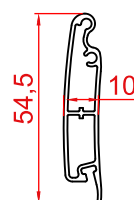

TK1452
Lame
Slat
414gr/m

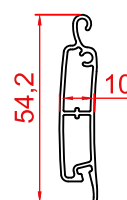

TK1455
Largeur de lame
High Slat
396gr/m

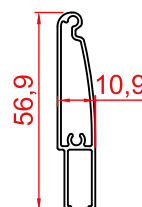

TK1433
Compensateur
Compensator
380gr/m

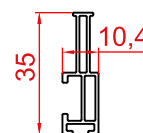

TK1434
Positionneur
Positioner
251gr/m

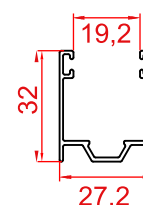

TK1431
Guide
Guide
320gr/m

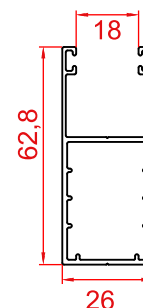

TK1451
Guide
Guide
672gr/m

	TK 1431 avec coffre interne TK1431 with internal box	TK 1451 avec coffre externe TK1451 with external box
Guide dédié Own guides		
Montage sur guide existant Assembly on existing guides	Oui Largeur minimum 17 mm Yes Minimum width 17 mm	Profondeur minimum 24 mm Minimum depth 24 mm
Anti-soulèvement Antilift	Oui - avec le verrou RA008- il est recommandé d'utiliser le moteur avec détecteur d'obstacle Yes - with bolt RA008. It is recommended to use motors with obstacle detection	
Poids au M2 Weight per sqm	9 kg	
Manipulation motion	Motorisée Motorized	
Pas de lame Slat pitch	50 mm – lames fermées closed 45 mm – lames fermées oriented	
Résistance au vent EN1932 Wind load EN 1932	Classe 6 Class 6	
Résistance mécanique UNI EN 13659 Mechanical endurance UNI EN 13659	Classe 3 Class 3	
Gtot avec vitrage de type classe C Gtot with type C window	Classe 4 Class 4	
Résistance thermique supplémentaire UNI EN 13125 Additional thermal resistance UNI EN 13125	Classe 4 Class 4	ΔR=0.15

GAMME RAL STANDARD STANDARD COLORS

RAL 1013 OP	Blanc perle mat Matte pearl white
RAL 7001 OP	Gris Argent mat Matte silver gray
RAL 7035 OP	Gris clair mat Matte light gray
RAL 9006	Aluminium brillant Shiny aluminium
RAL 9010 OP	Blanc pur mat Matte white
S113	Ivoire Soft Soft ivory
S910	Blanc soft Soft white

Effet bois: + 30% certains modèles demande une plus value additionnelle
Wood effect + 30% Some finishes may require an additional contribution

Pour toute autre couleur, nous consulter afin de procéder à une étude de faisabilité.
For all not included colors we will proceed to feasibility analysis and we may add surcharges.



ROLLTEK FRANCE

76 Allée Louis Blériot
30320 MARGUERITES



Tel. 04 66 37 72 51



www.voletroulantlamesorientables.com
contact@rolltekfrance.com



Rolltek France



Rolltek_france